

A CROSS OVER SOFA

GATHER



GATHER

A NEW CROSS OVER

Gather is a sofa program that has taken the best from two worlds; the practicality of a modular and the aesthetics of a stand-alone. The program allows you to setup configurations best suitable for your needs, without compromising on aesthetics or comfort.

Thin legs are mounted on a steel frame with free modules placed on top. This gives the program several benefits in production, logistics, configurations and assembly. The holistic expression of Gather is based on its chunky yet fitted volumes divided by its characteristic seam that goes around the sofa. A perfect sofa for the workplace or even your home.

Design Andreas Engesvik

GATHER YOUR COLLEAGUES



GATHER Sofas in your way. FEATHER Lounge chairs and tables are a perfect match.

A close-up photograph of a tan leather armchair. The image focuses on the curved, padded backrest and the side of the seat, showing the texture and stitching of the leather. A single black leg is visible at the bottom left. The background is a plain, light-colored wall and floor.

Whatever fabric you choose, GATHER is stylish and welcoming. Here in leather: Cognac (54035).



GATHER, 4 seats with chaise lounge, in leather: Cognac (54035).

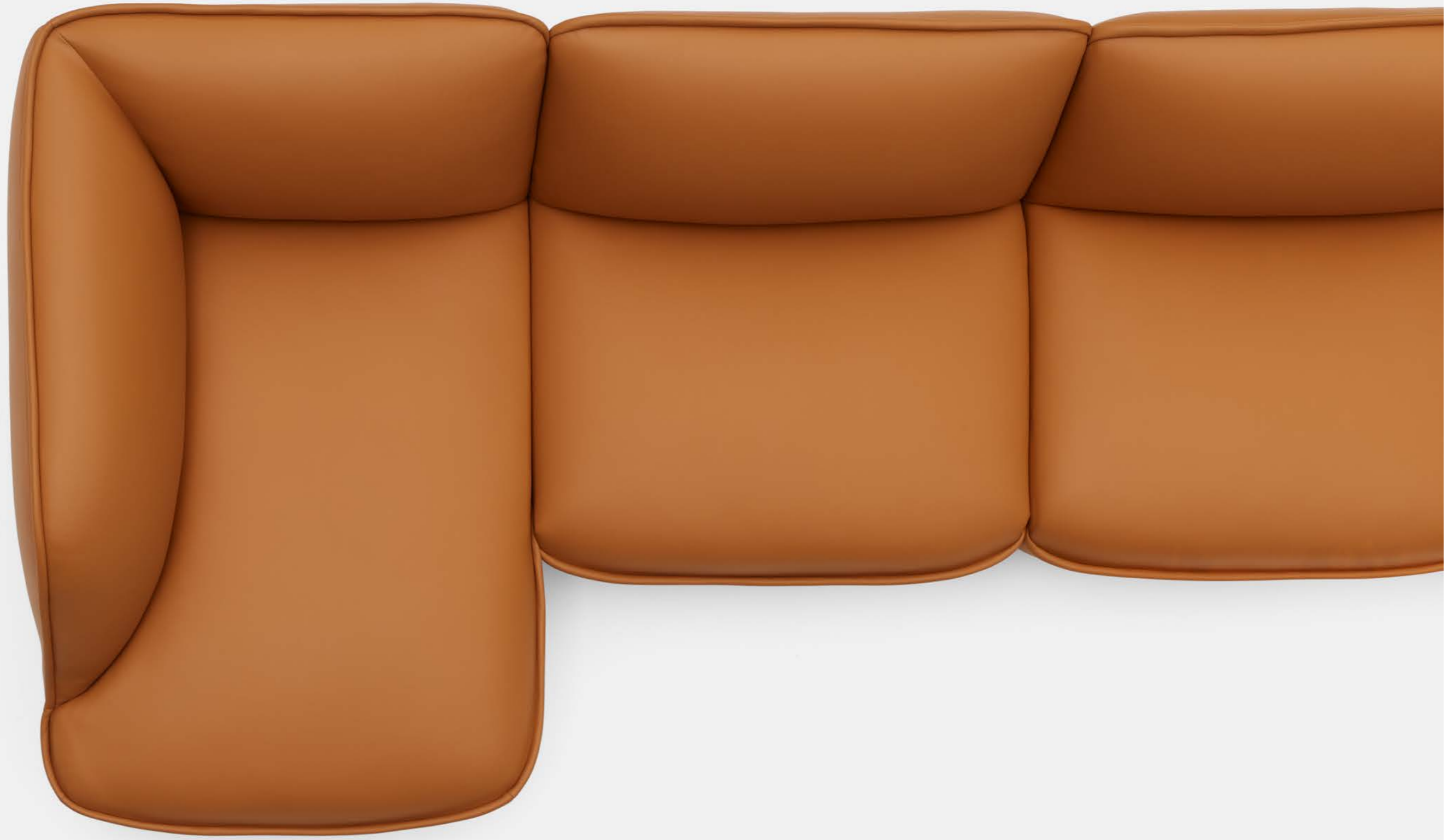

GATHER chaise lounge, in leather: Cognac (54035)



GATHER 2 x 1,5 seat. Fabric: Rime (521) champagne pink.



GATHER, 6 seats with corner and a footstool. Fabric: Pitch (grass green).

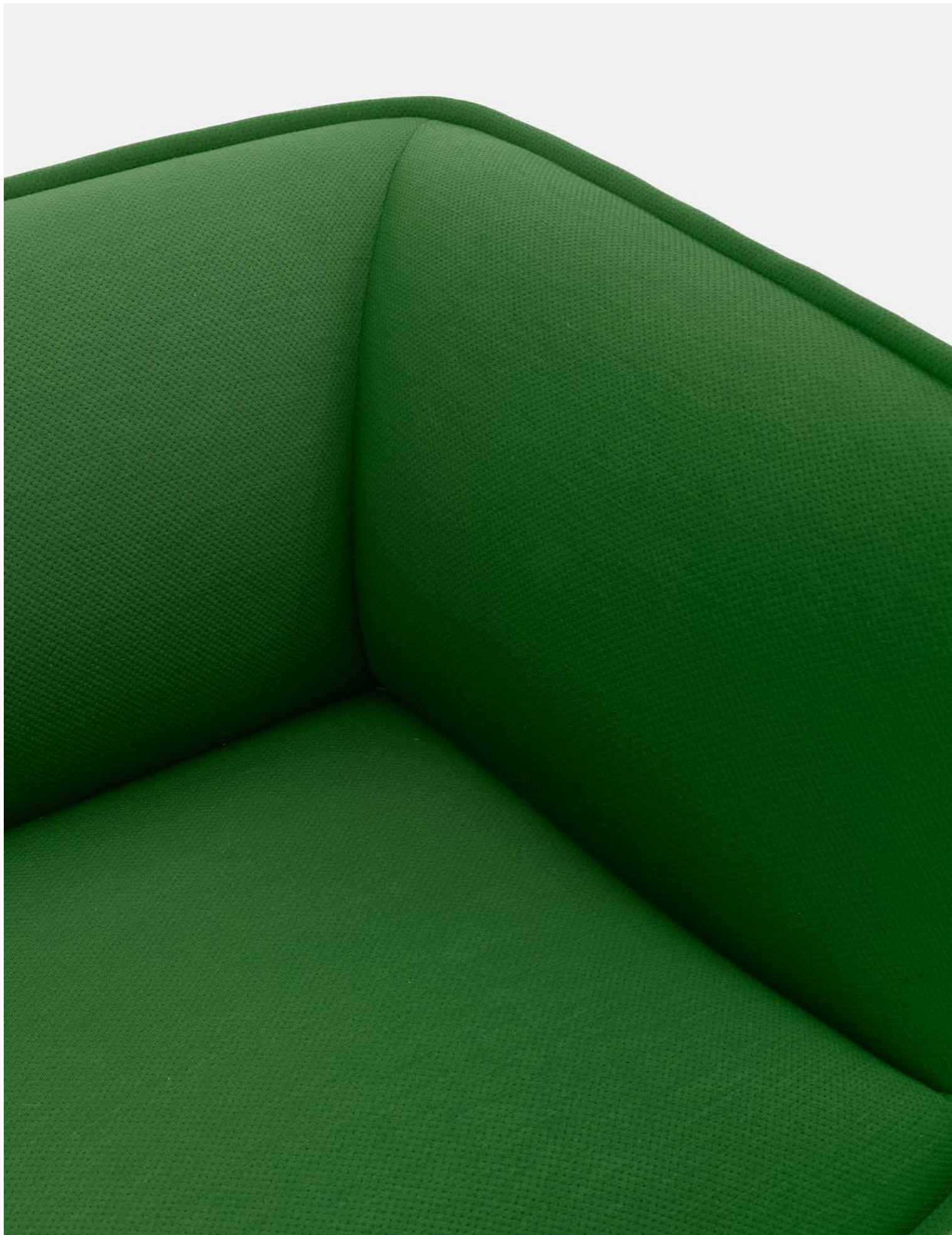

GATHER, at left, fabric: Rime (521) champagne pink, at right, fabric: Pitch (grass green) and a FEATHER Table with table top in carrara marble.

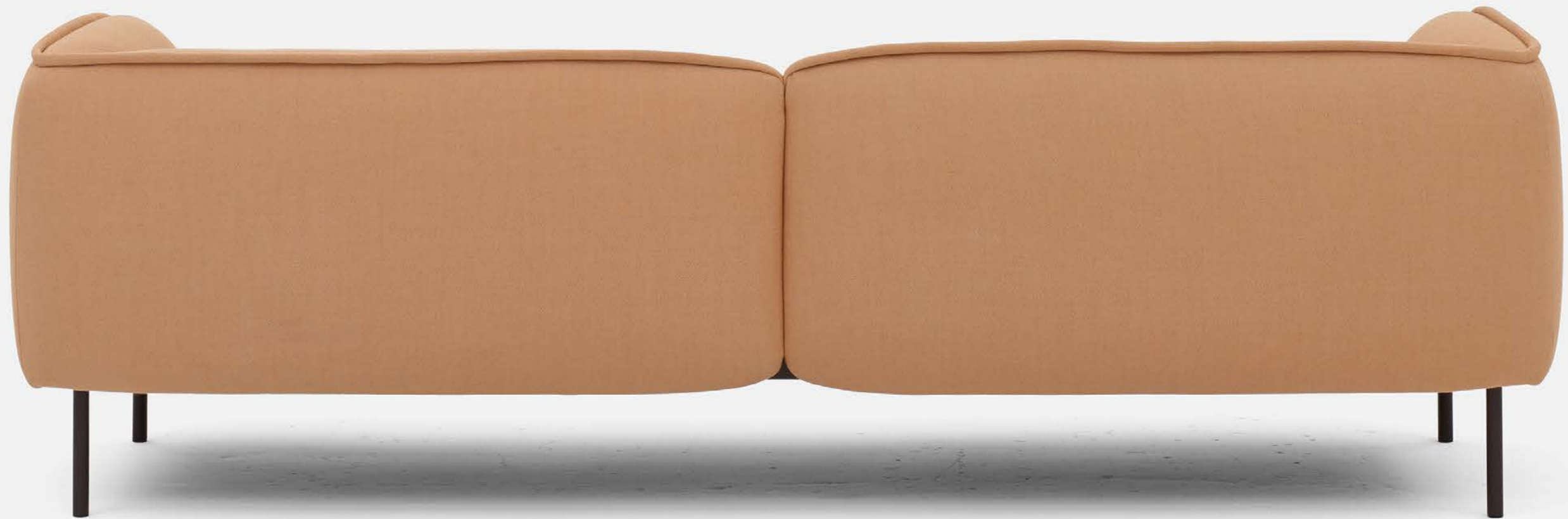

GATHER is good looking from all angles. Fabric: Rime (521) champagne pink.

MEASUREMENT [mm]

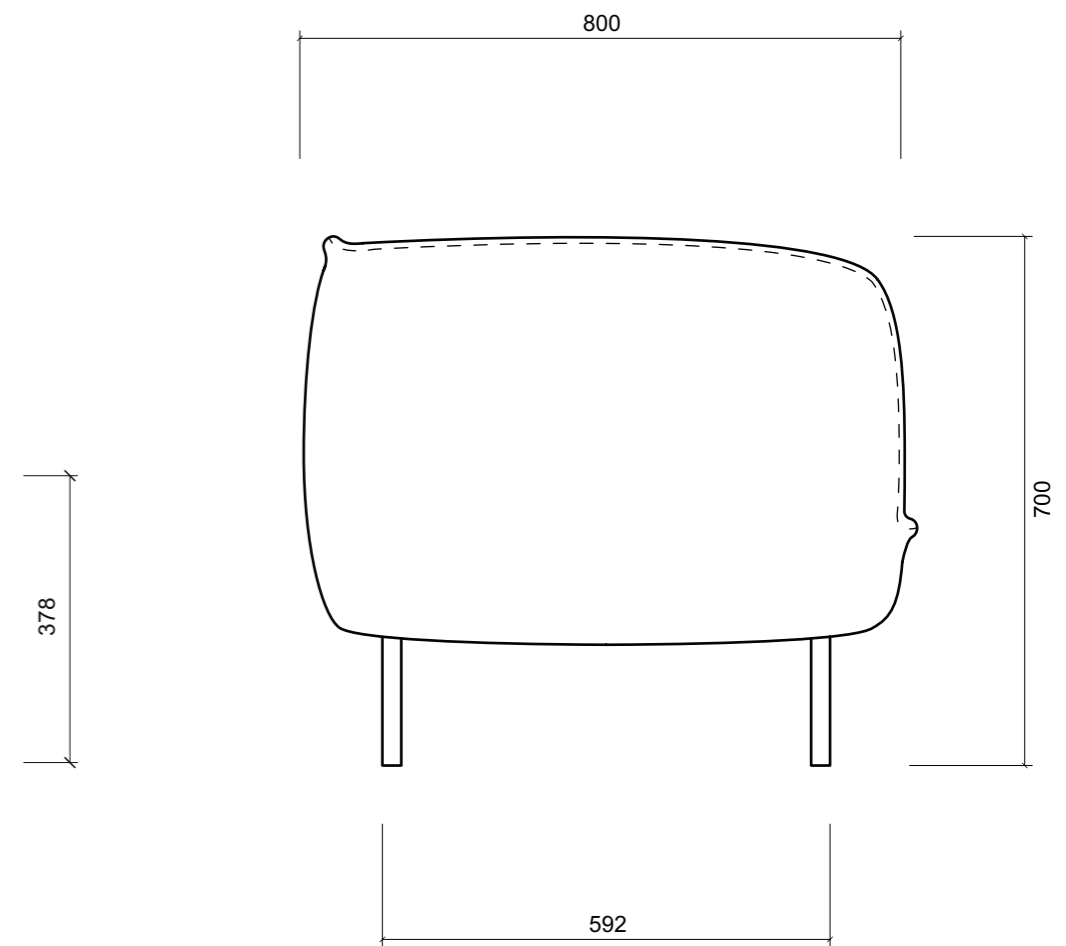
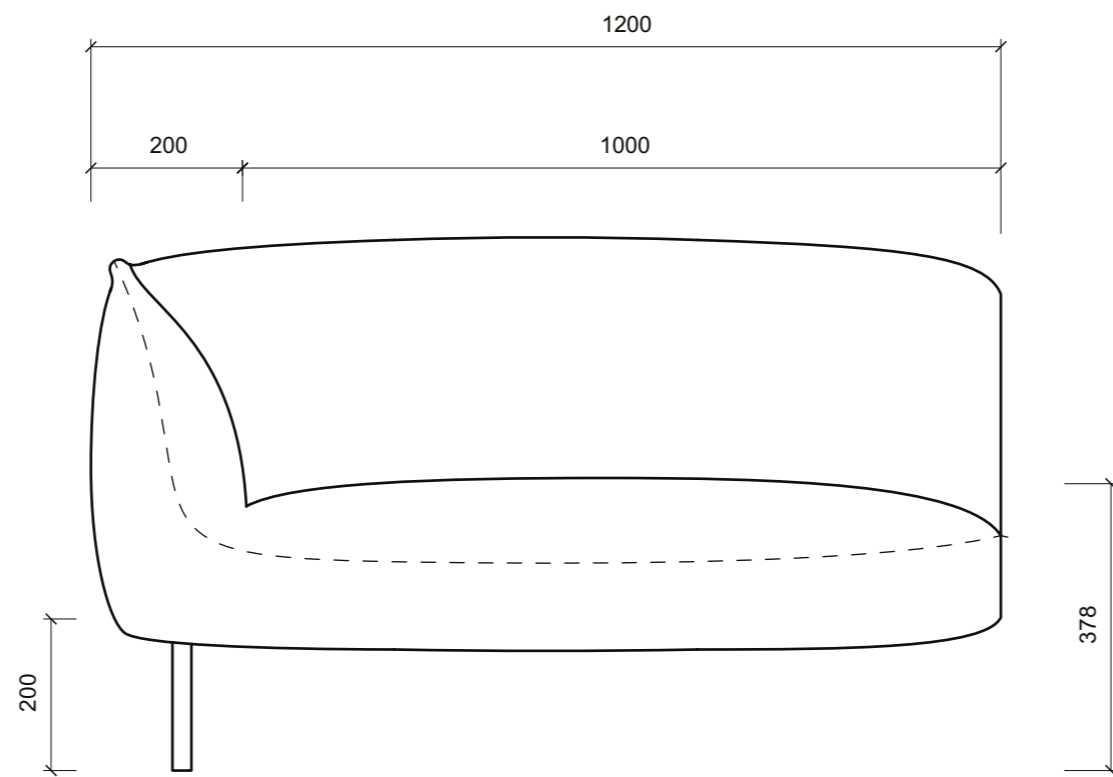
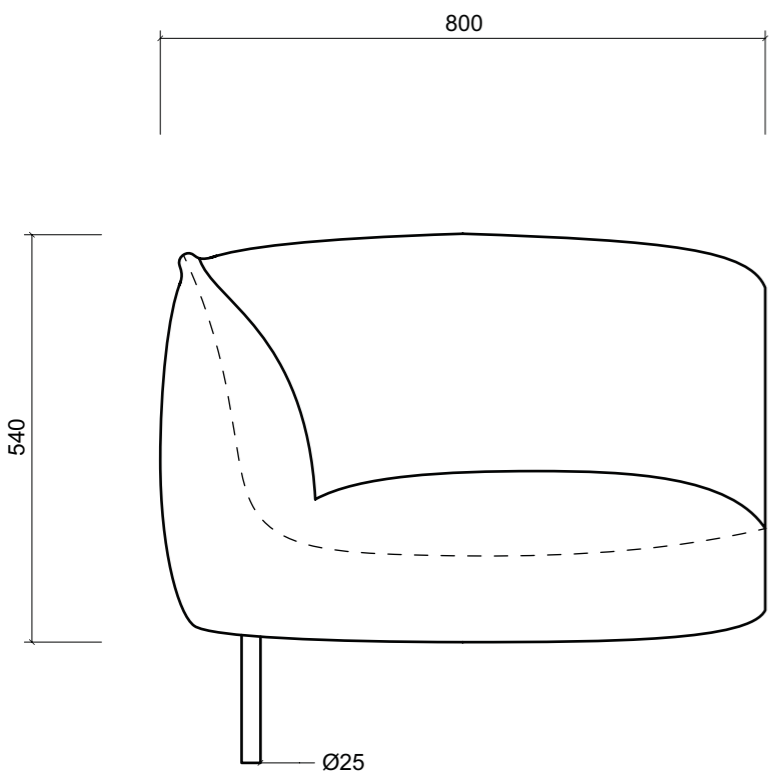

GATHER SOFAS

MODULES



CORNER SHORT
W: 800 D: 800 H: 378



MIDSECTION
W: 800 D: 800 H: 378



CORNER SHORT
W: 800 D: 800 H: 378



CORNER LONG
W: 1200 D: 800 H: 378



CORNER LONG
W: 1200 D: 800 H: 378

CHAISE LOUNGES



LEFT LONG
W: 800 D: 1200 H: 378



LEFT SHORT
W: 800 D: 1200 H: 378



RIGHT SHORT
W: 800 D: 1200 H: 378



RIGHT LONG
W: 800 D: 1200 H: 378



31KA1
W: 800 D: 800 H: 378



31KA9
W: 1200 D: 800 H: 378

FOOTSTOOLS

SOFA CONFIGURATIONS – EXAMPLES



31KA2
W: 1600 D: 800 H: 378



31KA3
W: 2400 D: 800 H: 378



31KA8
W: 2400 D: 800 H: 378



31KA5
W: 4800 D: 800 H: 378



31KA4
W: 2400 D: 800 H: 378

SOFAS WITH CHAISE LOUNGES



31KA6
W: 2000 D: 800 H: 378

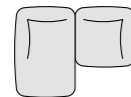

31KB1
W: 1600 D: 800 H: 378
Chaise lounge D: 1200

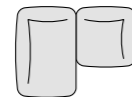

31KB3
W: 1600 D: 800 H: 378
Chaise lounge D: 1200

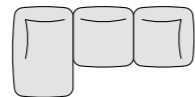

31KB7
W: 2400 D: 800 H: 378
Chaise lounge D: 1200

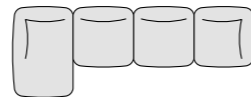

31KB5
W: 3200 D: 800 H: 378
Chaise lounge D: 1200

CORNER SOFAS

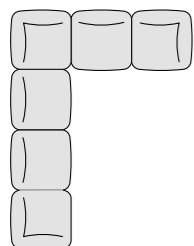

31KC1
W: 2400 D: 800 H: 378
Angular section D: 3200

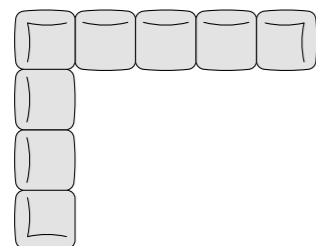

31KC2
W: 4000 D: 800 H: 378
Angular section D: 3200

MODULES

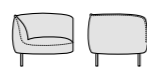

CORNER SHORT
W: 800 D: 800 H: 378



MIDSECTION
B: 800 D: 800 H: 378

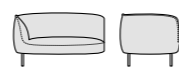

CORNER LONG
W: 1200 D: 800 H: 378

STANDARD OPTIONS AND FABRICS

Configure your version of Edsbyn's products in: my.edsbyn.com

SPECIAL DESIGN

If you can't find what you're looking for, please ask your salesman or contact us via our website: edsbyn.com

GATHER IS AN EDGE FAMILY



CLASSIC

This segment, with a focus on price, is aimed at companies and organisations that want to create workplaces for a low price. With simple but stable designs in combination with fewer versions, materials and colours, prices are kept down.



BUSINESS

The segment with a focus on function. Classic is aimed at organisations and companies that want to create customer adapted and functional workplaces with long lifetimes for a low cost over the product life-cycle.



EDGE

The segment with a focus on design, aimed at companies and organisations that see a well-designed workplace as an important competitive advantage, both when it comes to employer branding to attract and retain competent employees and for reinforcing the brand through the office.

CERTIFICATES



CERTIFIED PRODUCTION

Edsbyverken is certified according to quality and environmental management standards: ISO 9001 and ISO 14001.

We expect materials from our suppliers to fulfil the criteria for environmental certification – and we require our suppliers to accept ethical and social responsibility, just like Edsbyn does.



MÖBELFAKTA

CERTIFIED PRODUCTS

Gather is under approval for certification according to Möbelfakta. This means that:

Technical quality standards for sustainability, stability and safety and for surface resistance.

Environmental standards for materials and products.

The environmental standards primarily relate to raw materials and components used during manufacture, while the product standards relate to the completed item of furniture.

Producers and subcontractors undertake systematic occupational health and safety work and comply with current occupational health and safety legislation.



THE NORDIC ECOLABEL

Edsbyn was the first manufacturer of office furniture to be Nordic Ecolabelled.

Our latest example of a Nordic Ecolabelled product is the Ease screen system which is manufactured from a material normally used for sound absorption in vehicles. It consists of recycled textiles and PET bottles, which makes Ease a good example of sustainable product development.

SUSTAINABILITY SINCE 1899



FSC APPROVED FORESTRY

The forest and access to wood was one of the main factors when Edsbyn began in 1899. At an early date, we were economically (and ecologically) conscious of making the most of our raw materials. The Fanett Windsor chair, of which over 5 million were sold, was produced from waste wood from our ski manufacturing. Waste wood is today supplied to the power station and our wood comes from FSC approved forestry.

EASE, our latest screen system, is manufactured from recycled textiles and PET bottles. We still think about recycling, now as then.

At Edsbyn, we work constantly to improve our processes and furniture production – in order to be the obvious choice for those who select office furniture on the basis of environmental and sustainability factors.



DESK CONTENTS

60% Steel
36% Board material
03% Miscellaneous
01% Veneer

STORAGE UNIT CONTENTS

88% Board material
05% Veneer
04% Steel
01% Aluminium
01% Plastic
01% Other

All component materials fulfil the requirements for environmental certification according to Möbelfakta.



OF WHICH RECYCLED

70% recycled material in MDF
52% recycled mtrl in particleboard
25% recycled material in steel

RECYCLABLE

99% desks
99% storage units

RENEWABLE RESOURCES

36% desks
88% storage units

THE WORKING OFFICE

The human being is social.
So ideas and development take off
when we meet and work together. This means
the office is necessary as a meeting place even if
the work itself is changing. And new ways of working
demand new kinds of furniture that help the
office to function and the staff to deliver.

We call this
Edsbyn – the working office.

