

Manual

Kodlås 57
Dial lock 57

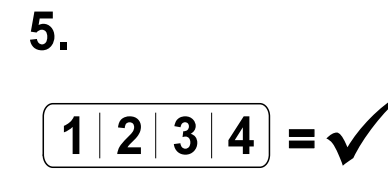

Ändra fabriksinställd kod (första gången) Change factory set code (first time)

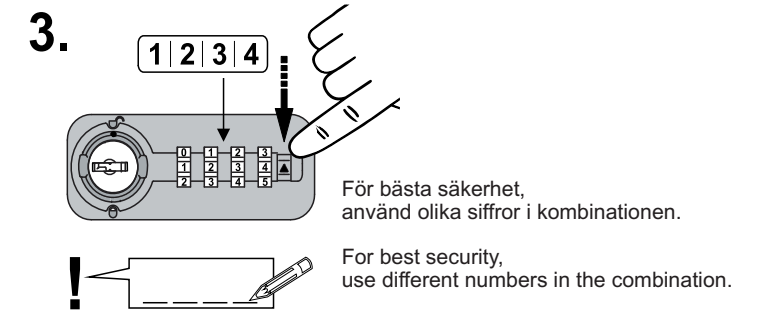
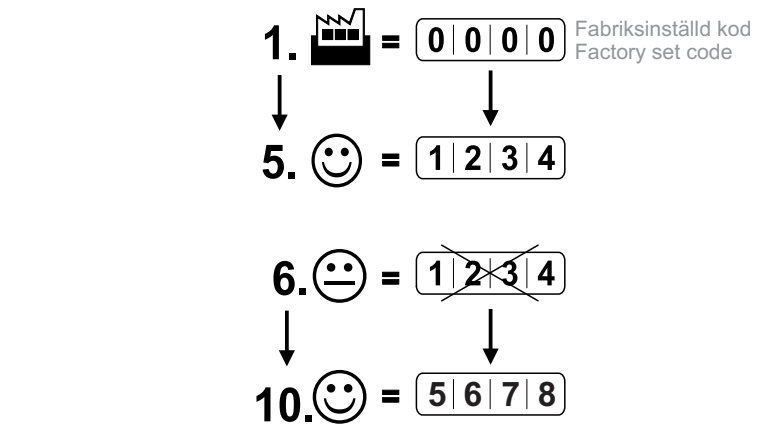
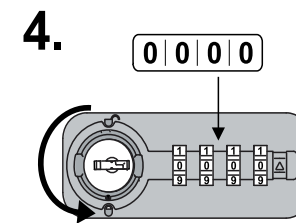
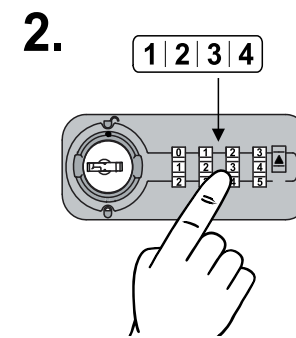
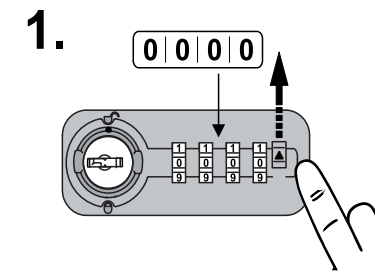

Ändra koden Change Code

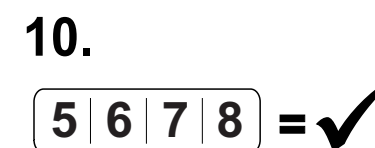
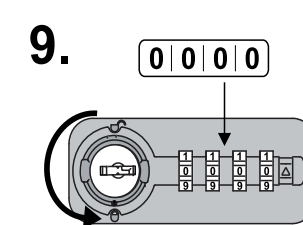
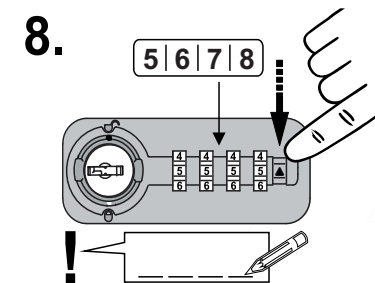
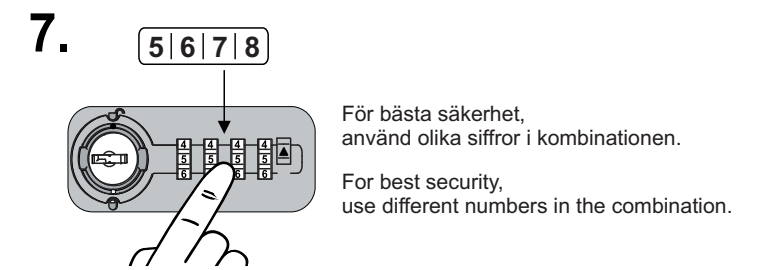
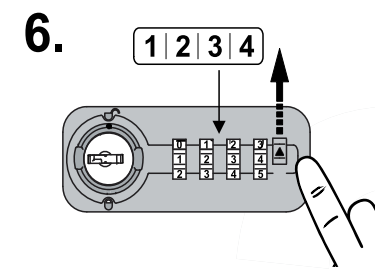

AB Edsbyverken, Box 300, SE-828 25 Edsbyn
Tel/Phone +46 (0)271-27500, Fax +46 (0)271-27501
www.edsbyn.com

Date: 2014-09-12

Nr. 00530227-B

Nödöppning
Emergency opening

1.

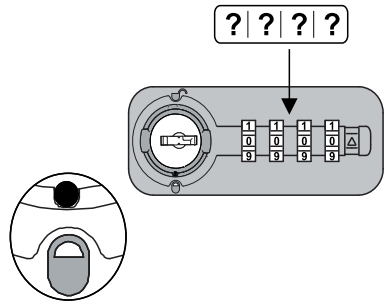

2.

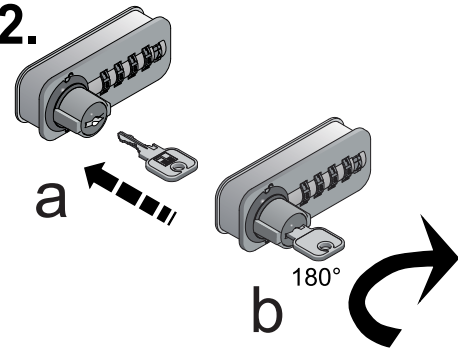

3.

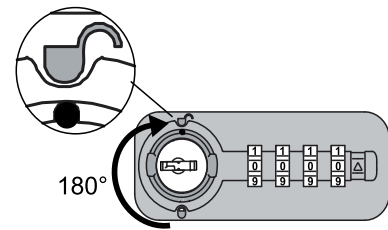

1. ☹️ = [?][?][?][?]



3. 😊 = 🔓

OBS! Nyckeln får inte tas ut när låset är i upplåst läge.
NOTE! The key can not be removed when the lock is unlocked.



Beställs separat (artikelnummer 67063373)
Has to be ordered separately (art. no. 67063373)

Bortglömd kod
Forgotten code

1.

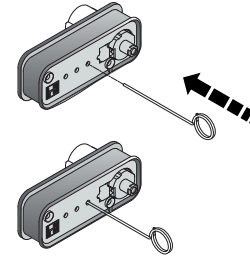

2.

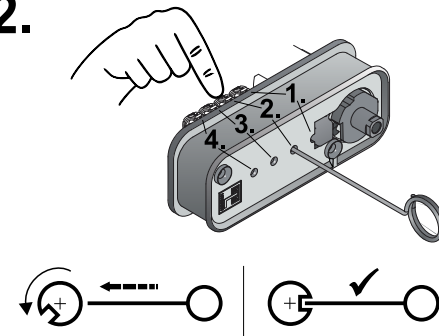

Om skåpet är låst måste nyckel användas för att öppna.
If the cabinet is locked, the key has to be used to open.



Beställs separat (artikelnummer 67063374)
Has to be ordered separately (art. no. 67063374)

1. ☹️ = ☁️ 3 5 4 7
9 0 6

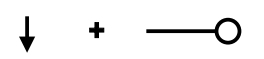

3. 😊 = ☁️ 5 6 7 8

3.

