

Monteringsanvisning - Assembly instruction

Ease soffan

Ease sofa

Kabelhantering säljs som tillbehör, kan eftermonteras.
Cable management is sold as accessories, can be retrofitted.



AB Edsbyverken, Box 300, SE-828 25 Edsbyn
Tel/Phone +46 (0)271-27500, Fax +46 (0)271-27501
www.edsbyn.com

Date: 2016-12-28

Nr: 00530253-D

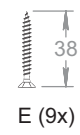
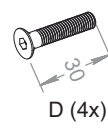
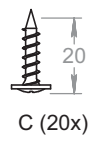
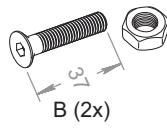
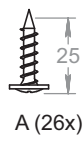

1

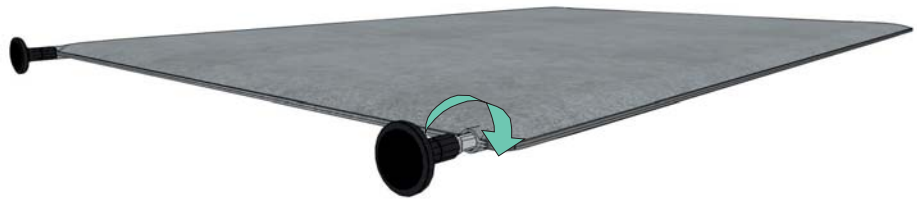

Skruva fast fötter i skärmarna.

Assemble the feet into the screens.

2

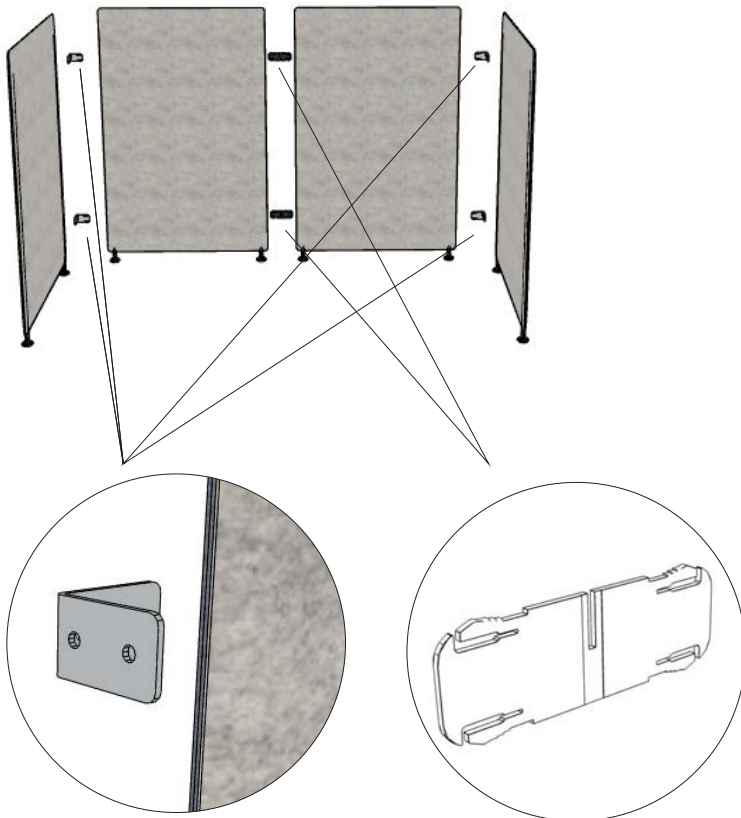

För in kopplingsbeslag tills de bottnar.

Insert the connection fittings until it reaches the bottom of the screen.

3

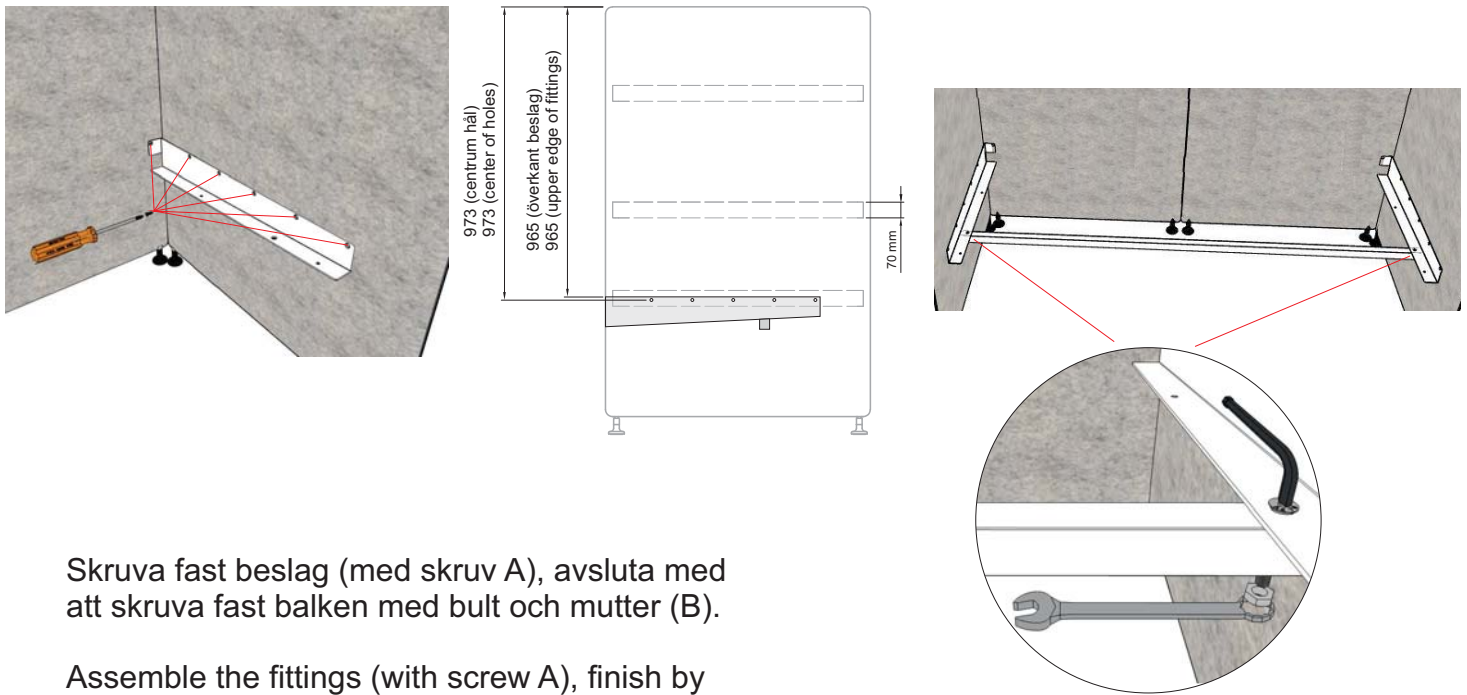

Skruva fast beslag (med skruv A), avsluta med att skruva fast balken med bult och mutter (B).

Assemble the fittings (with screw A), finish by screwing the beam with bolt and nut (B).

4

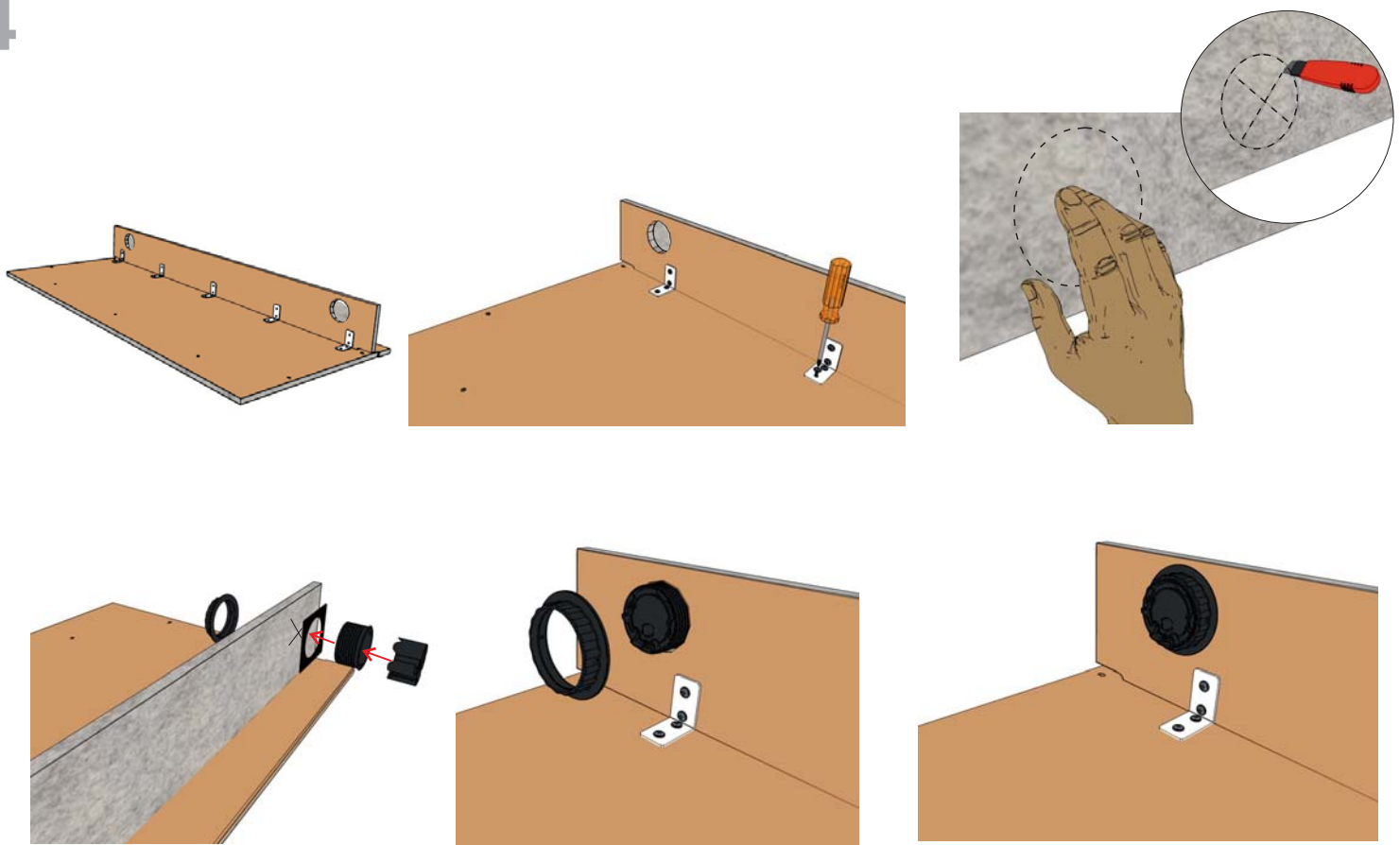

Skruva samman front och sits med vinkelbeslag (skruv C). För att montera eventuella elkontakter, känn på fronten för att känna var hålet är, skär ett kryss och tryck sedan dit elkontakten (börja med täcklocket).

Screw the front and seat with angle brackets (screw C). To assembly any power plugs, characterize where the hole is with a hand, cut a cross and then finish with assembling the power plug (start with the cover).

5

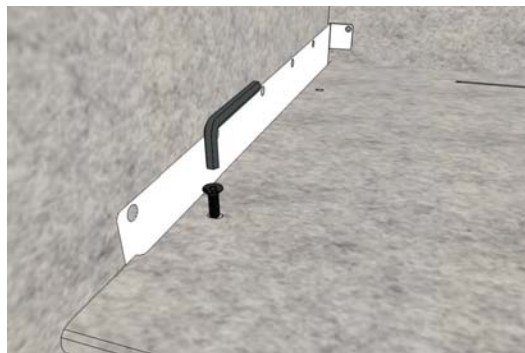
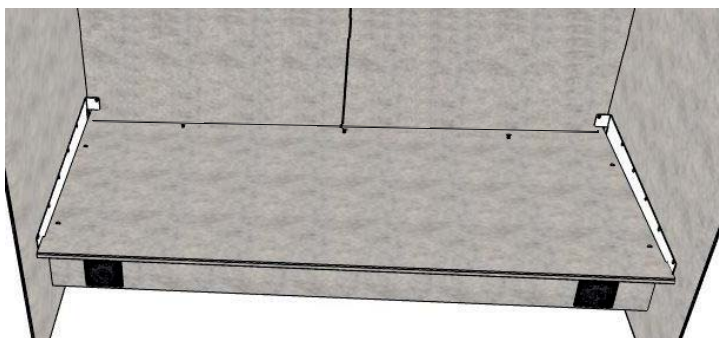

Skruva fast sitsen i beslagen (skruv D).

Assemble the seat in the fittings (screw D).

6

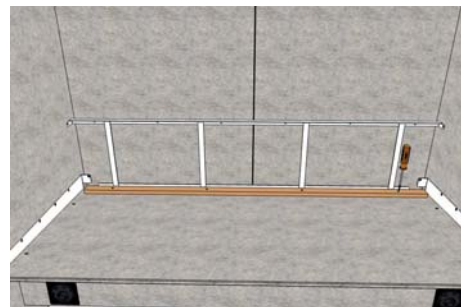
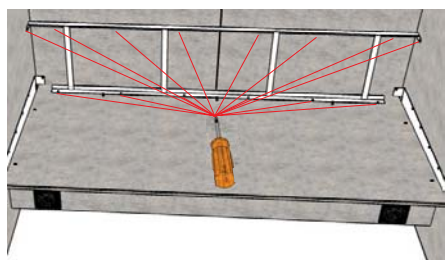

Skruva fast förstärkning för rygg i skärmarna och sitsen (skruv A).

Avsluta med att montera centrumtappar i slån som sedan passas in i slitsen och skruvas fast (skruv E).

Screw the reinforcement to the back of the screens and to the seat (screw A).

Finish by assemble the dowel in the crossbar which is then fitted into the slot and screwed (screw E).

7



Placera ryggskivan mot slån och skruva fast (skruv E).

Place back panels toward the crossbar and screw (screw E).