

Monteringsanvisning - Assembly instruction

Oval pelarfot med kabelgenomföring
Oval column stand with cable inlet



AB Edsbyverken, Box 300, SE-828 25 Edsbyn
Tel/Phone +46 (0)271-27500, Fax +46 (0)271-27501
www.edsbyn.com

Date: 2016-02-29

Nr: 00530198-A

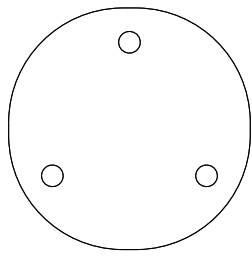

A

x2



B

x6

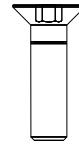

C

x6

1



Denna sida ned.
This side down.

2



Placera täckringen runt röret.
Place the cover ring around the pipe.

4



Placera sedan skivfästet på rören.
Place the tabletop hold on the pipes.



Montera skivfästet med brickan (A) samt sex skruvar (B).
Assemble the tabletop hold with the bracket (A) and six screws (B).

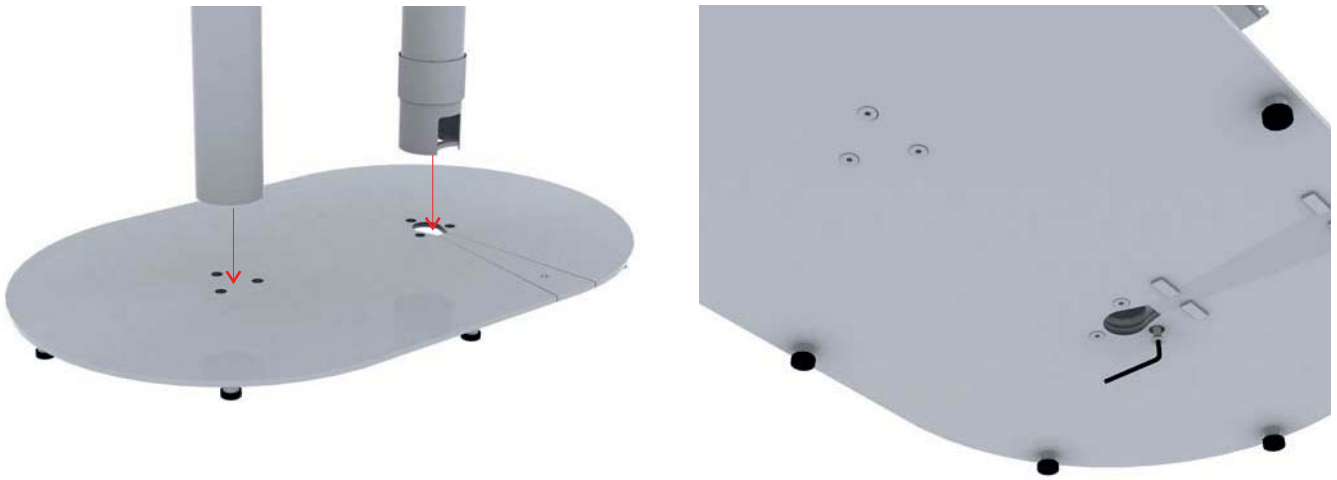

Placera rören på foten, montera med de sex medföljande skruvarna (C).
Place the pipes on the foot, assemble with the enclosed six screws (C).



Ta bort luckan med en insexnyckel för att enkelt dra sladden under foten.
Remove the door with an allen key for easy wiring under the foot.

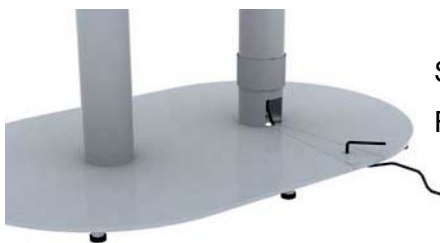

Skruva sedan fast skruven igen.
Fasten the screw again.



Täck sedan hålet på röret med täckringen.
Cover the hole on the pipe with the cover ring.

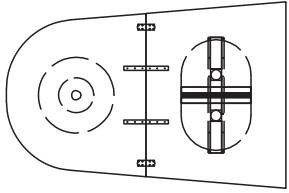

Komb 01

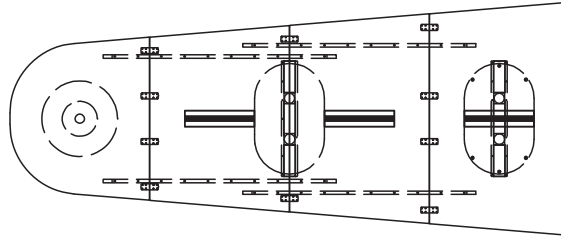

Komb 05

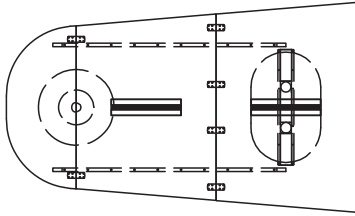

Komb 02

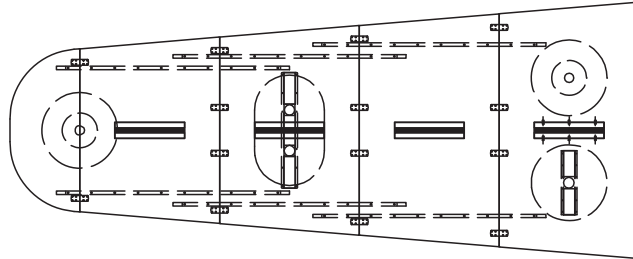

Komb 06

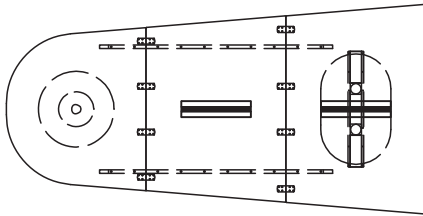

Komb 03

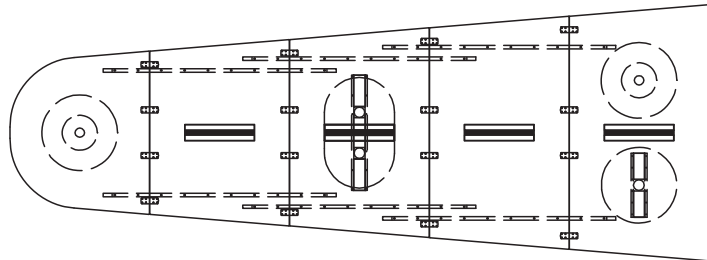

Komb 07

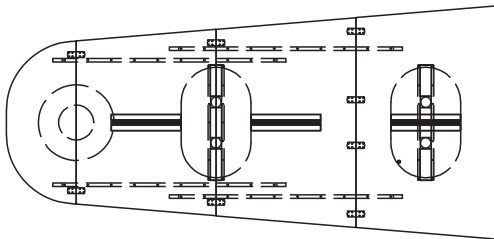

Komb 04

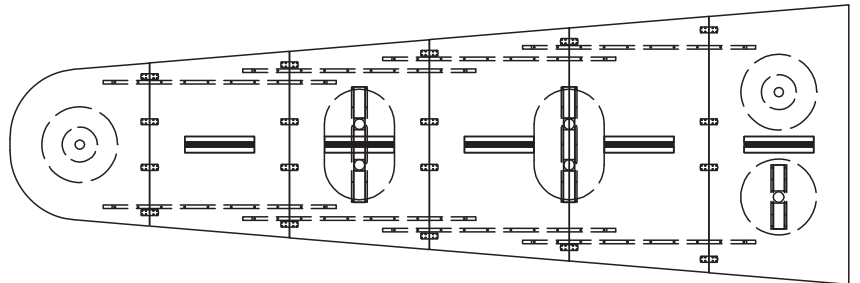

Komb 08